

FABRICATION GUIDELINES

IceStone[®]
MADE IN THE USA



Dear IceStone Certified Fabricator,

IceStone has been crafting its premium durable surfaces made from 100% recycled glass, Portland cement, and non-toxic pigment in the US since 2003. To date we have saved over 20 million pounds of glass from entering landfills.

We strive to design surface solutions that won't compromise human or environmental health. Our commitment to creating beautiful and sustainable surfaces is fostered by every decision we make. IceStone has become the premier choice for architects, designers, fabricators and homeowners nationwide.

We believe that quality craftsmanship, social responsibility, and environmental stewardship are equally essential to the success of our business and yours.

Thank you for partnering with us on our journey. To learn more about IceStone's mission and certifications please visit www.icestoneusa.com.

Sincerely,
The IceStone Team



TABLE OF CONTENTS

SECTION 1:

4	Disclaimer
5	Applications
5	Standard Slab Size and Weight Technical
6	Specifications and Certifications Dust
7	Inhalation Exposure
7	Certified Fabricator & Warranty Program
8	Proper Handling & Inventory Storage
9	Unloading a large crate
10	Slab Storage Procedure
14	Outdoor Installations

SECTION 2:

15	Fabrication Instructions
15	Fabrication Tools & Safety Equipment
16	Marble Institute of America Standards
16	Color Matching, Batch Numbering, and Slab Identification
17	Removing Bow From Warped Slabs via Rewetting
18	Fabricating IceStone
19	Radius Corners / Edge Profiles
20	Aprons and Built Up Edges
20	Structural Support
21	Cutouts and Reinforcing Rod Supports
22	Under counter sink mounting specifications
22	Soap Dispenser Placement
23	Dishwasher Support
23	Cantilevers and Overhangs
23	Installation Overview
24	Seaming
25	Sealing
25	Heat Tolerance
26	Surface Repair
27	Pop Outs
28	Microporosity

SECTION 3:

30	For Your Customer
31-32	Care and Maintenance
33 34	Warranty Registration Form Contact Information

Disclaimer

IceStone durable surfaces are only sold to Certified Fabricators. Please contact Customer Service if you are interested in becoming a Certified Fabricator. We have a brief Online training video for certification purposes. You can call us at 718-624-4900 or email us at customerservice@icestoneusa.com to get started! The fabrication and installation of IceStone slabs is similar to quarried stone, but has unique requirements that must be followed for optimum performance. IceStone's fabrication guidelines must be followed to qualify for a warranty claim.

IceStone, LLC is not responsible for variation between samples or printed materials and slabs received upon delivery. Please ensure that you and your clients have up to date samples that accurately reflect IceStone's current palette and production.

[All slabs must be inspected upon receipt according to IceStone's Terms & Conditions.](#)

Variation in glass size, shape, color, and gauge are inherent to IceStone slabs, which are hand crafted using recycled materials. Project layout and the final quantity of slabs needed should be determined before slabs arrive at the fabrication shop. Slabs must also be inspected for color matching prior to fabrication, and examined again for overall quality while dry-fitting at the job site. Any defective areas in the slab must be reported to IceStone, LLC immediately with panel ID number, color, shipment date, nonconformity details and digital photos. IceStone will not reimburse labor or material costs when defective slabs are cut and installed without adequate inspection.

After installation, please ask the customer to inspect the job to ensure satisfaction. [The fabricator/installer must make sure the end user has a copy of the most recent IceStone Care and Maintenance guidelines.](#) This can be obtained by visiting IceStone's website, or by contacting customer service. (There should also be a copy attached at the end of the fabrication guidelines).

This manual is published by IceStone, LLC and supersedes all previous manuals. Content is subject to change. For the most recent version of Fabrication Guidelines, please visit IceStone's website: www.icestoneusa.com.

IceStone® is a registered trademark of IceStone, LLC.

Applications

IceStone surfaces can be used as:

- Kitchen countertops
- Bathroom vanities
- Backsplashes
- Reception areas
- Conference tables
- Cash transaction areas
- Window sills, desk tops, and more

Commercial Food Service Countertops

DO NOT install IceStone surfaces under heat lamps or areas where the surface will be exposed to extended periods of direct heat. Heat trays, heat sinks, soup warmers, etc., should not be installed in IceStone surfaces.

Standard Slab Size and Weight

Width x Length	108 inches x 60 inches (approx. 45 square feet)
Thickness	1.25 inches/3cm thickness
Weight	15.15 pounds / square foot (approx. 682 lbs/ slab)

** Please note that the slab dimensions are nominal and are only to be used for storage and transportation purposes. Actual usable slab surface will be slightly less per side, and varies from slab to slab. Please inspect the perimeter before cutting.*

Pre-cut half slabs are available in select areas. Contact your IceStone distributor for availability.

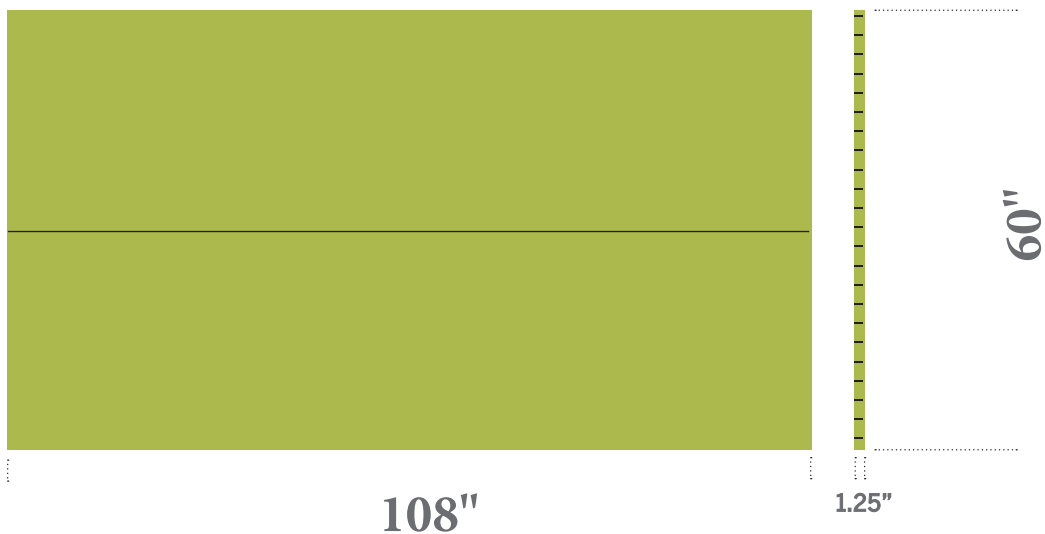

Technical Specifications and Certifications

Property	Test Standard	IceStone Results
Compressive Strength	ASTM C – 109	13,000 psi - 16,000 psi
Flexural Strength	ASTM C – 203	890 psi
Specific Gravity	ASTM C – 97	2.31 g/cm ³
Porosity/Absorption	ASTM C – 642	0.18% unsealed
Chemical Durability	ASTM C – 1260 for ASR reactivity	0.49% 300 cycles
Freeze Thaw	ASTM C – 666	0.05%
Stain Resistance	ASTM E – 84	Yes, when used with recommended sealers
Fire Rating	ASTM E – 84	Class 1(A) Flame spread index 0 Fuel contribution 0 Smoke density index 0
Coefficient of Static Friction	ASTM C – 1028	0.69 Polished dry 0.61 Polished wet 0.71 Honed dry 0.62 Honed wet 0.85 Sandblasted dry 0.77 Sandblasted wet



Dust Inhalation Exposure

IceStone is one of the safest stone materials for fabricators to work with. The silica IceStone contains is nearly undetectable and is mostly amorphous silica from the glass that does not enter the air as does crystalline silica which is found in granite and Quartz. Crystalline silica goes airborne when cut or grinded dry.

To minimize dust concentrations in breathing zones, IceStone requires using either wet diamond tools or water jets when cutting and polishing IceStone slabs, as well as proper local ventilation and collection equipment. Fine particles that may be generated while fabricating IceStone surfaces with wet diamond tools or water jets fall within the category of nuisance dusts. If ventilation methods are inadequate to keep dusts levels below specified limits, wear a properly fitted particulate respirator approved by the National Institute for Occupational Safety and Health. Please review IceStone's Safety Data Sheet for more information.

Certified Fabricator & Warranty Program

IceStone offers free certification trainings to fabricators. Only Certified Fabricators can purchase IceStone.

Certified Fabricators must follow all procedures listed in the most recent version of the IceStone Fabrication Guidelines and Care & Maintenance Guidelines.

To become a Certified Fabricator, please contact customer service at customerservice@icestoneusa.com.

We have a brief training video for certification. Only installations by Certified Fabricators are eligible for IceStone's Commercial 10-Year and Residential 10-Year Limited Warranties.

The home or building owner must register their installation on IceStone's website within 30 days of installation to qualify for warranty. The warranty registration form is located on Page 33 of the fabrication guidelines.

Receiving IceStone Slabs

- **When you receive your shipment from IceStone a thorough visual inspection of the material for color consistency and defects must be done immediately.**
- All slab loads must be inspected for damage before the POD or BOL is signed.
- If shipment is not inspected and the POD or BOL is signed, and damage is discovered later, the carrier will not pay any money toward a future claim.
- If the driver will not wait for the shipment to be inspected, note on the POD or BOL: Hidden damage possible.
- Any time you see damage, A-Frame carrier damage, or suspected damaged, please take multiple pictures from multiple angles. Do not cut into the slab if it is defective. Once a slab has been cut or installed, it can not be returned to IceStone for credit or refund.

Proper Handling & Inventory Storage

IceStone slabs weigh approximately 682 lbs, and a full crate of twelve slabs can weigh as much as 5,800 lbs including the A – frame crate. Be sure forklifts can handle this weight before moving any crates or material.

Unloading IceStone shipments

A thorough material inspection **MUST** be completed before securely storing IceStone. All shipments must be inspected upon delivery (see above) and any claims or damages must be reported immediately.



1. Unload delivery crate from the flat bed or LTL box truck using a forklift. Always move crates with a forklift. Do not push, pull or drag crates. IceStone crates are for delivery purpose only. Do not store IceStone slabs on delivery crates.



2. Move crates to designated indoor area for slab inspection
3. Follow the procedure for opening small and large crates (pages 9 to 10).

Unloading a large crate



1. Fold back the protective Tyvek wrap
2. Push a wedge in between the slabs to create a space for the clamp
3. Position the clamp at center of slab and engage clamp switch
4. Repeat steps 2-3 to unload the rest of the slabs
5. Slowly and carefully remove the slab from the crate.
6. Once again, thoroughly inspect the slab for color and quality

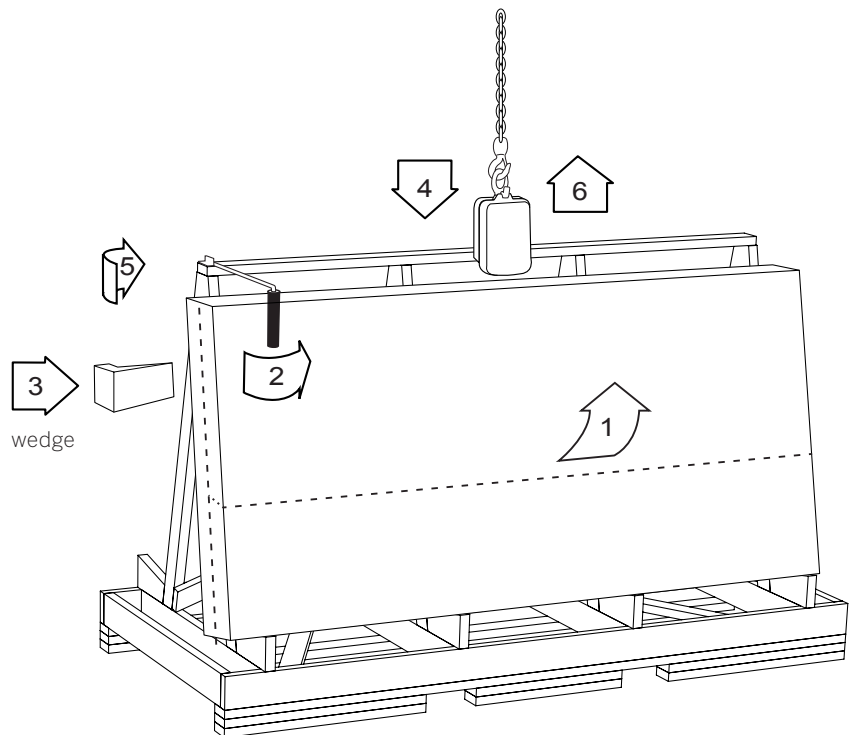
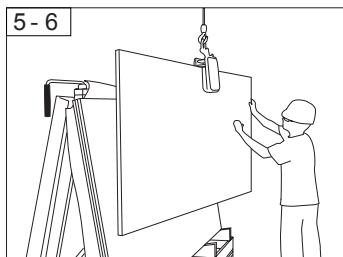
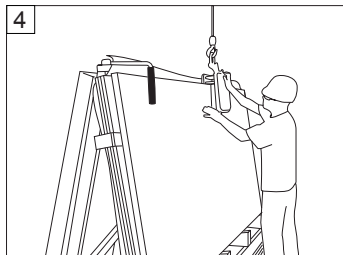
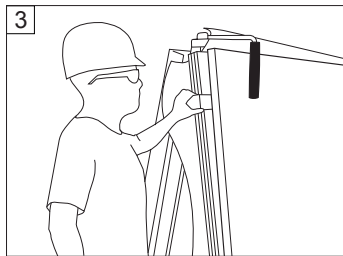
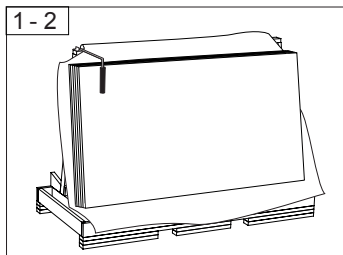

Slab Storage Procedure

A thorough material inspection must be done before securely storing IceStone slabs; inspect your delivery upon receipt and submit any damage claims immediately.



1. Place the first slab on the pipe rack or A-Frame with the polished face against the frame or rack.



2. Place the second slab with the polished side facing out (the back of the second slab should be against the back of the first slab).

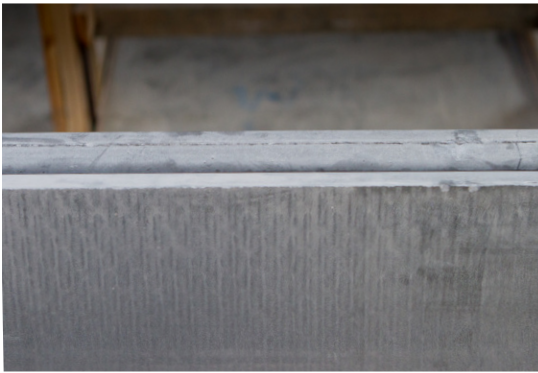

3. Place the third slab with the polished face against the polished face of the second slab. The unpolished face of the third slab will face out. Ensure that the bottom edges of slabs are touching. Unload all the slabs following this procedure.



4. When stored on pipe racks, slab should not be vertical; instead, position the slab at an approximately 20 degree angle from vertical position.

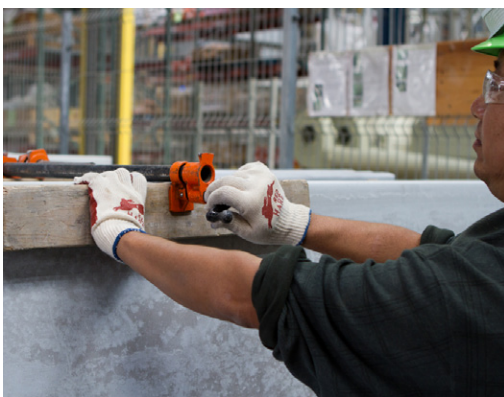

5. After unloading, inspection and relocation, begin clamping process.
6. Use two bar clamps spaced 24" from top right hand and top left hand edges of the slab. Tighten the clamps to first resistance. Do not overtighten.
7. Use two bar clamps spaced 24" from bottom right hand and bottom left hand edges of the same slab. Tighten to first resistance. Do not overtighten.



8. When adding or removing slabs from inventory, always follow the above procedure.

Indoor Storage Only

IceStone MUST always be stored indoors and in a vertical position. IceStone should never be stored flat! Do not leave slabs laying overnight on a saw or table

Even tarped slabs can stain, etch, warp, or crack when exposed to weather elements. The slab shown in Figure 1 was stored outside and damaged by acidic rainfall condensation under a tarp.

FIGURE 1
Example of a slab that was etched from condensation



Shipping IceStone slabs on a flatbed truck

Slabs that are not in a crate can be loaded onto:

- A metal A-frame that is mechanically secured to the flatbed of a truck,
- A metal or wooden A-frame secured to the bed of a pickup truck, or
- A portable A-frame that can be removed from a box truck, loaded, and then placed back in the box truck and secured

In all of these cases, at least two vertical straps are required to secure the slabs to the A-frame. IceStone will not load loose slabs onto a box truck that does not have a removable A-frame, as the height of box trucks prevents loading with a boom or overhead crane. Whether a truck, A-frame, or strap meets the requirements for carrying and/or transporting our slabs is completely at the discretion of IceStone, LLC.



1. At least two people must guide the slab to the designated truck. If the slab is being moved with an overhead crane, one worker should operate the crane, while the other steadies the slab as to reduce extraneous movements which could result in cracking. If the slab is being moved via a boom, one worker should operate the forklift, while the other worker steadies the slab.



2. When maneuvering the slab onto the truck, at least one worker must help the driver rest the slab on the A-frame or backer slab in order to make sure the slab remains level throughout the process.



3. Once the slab is on the truck, the driver should secure the slab using at least two vertical straps to help evenly distribute the pressure along the slab. Tighten the straps just enough to restrict movement of the slab during transportation. Any excess tightening may lead to cracks.



4. Add padding where the strap meets the slab at the top and at the bottom. The padding will reduce the tension on the slab during transit.

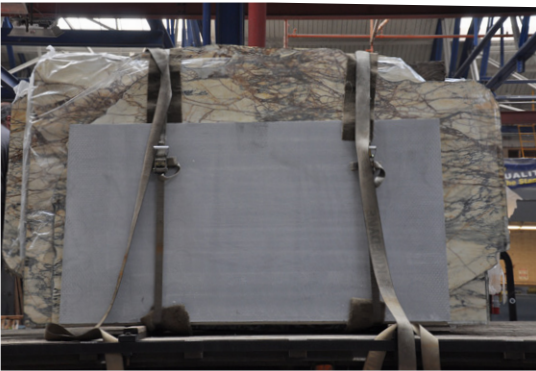

5. This picture illustrates an IceStone slab on a A-frame secured to the truck against a backer slab. Slabs should be loaded face to face, back to back. All loose slabs of IceStone must be loaded on a A-frame that is secured to a truck. While backer slabs are not mandatory, it does offer more protection than a slab being flush against a metal or wooden A-frame.

VEHICLE LOADS

It is the responsibility of the driver to ensure that the load is within the legal carrying capacity of the vehicle. Allow approximately 682 lbs per IceStone slab, plus the weight of any other items already loaded on the vehicle.

SECURING THE LOAD

It is the responsibility of the driver to ensure that the load is fully supported and safely secured to the vehicle prior to leaving IceStone's premises. IceStone will not secure the load to your vehicle. All transporting A-frames must be secured to the truck. IceStone reserves the right to refuse loading material on a truck in which A-frames are not secured to the bed of the truck.

Anytime IceStone material is being transported when exposed to outdoor elements, the material must be tarped.



OUTDOOR INSTALLATIONS

IceStone is suitable for outdoor installations under specific criteria which must be met to fulfill our warranty on material. Though IceStone will make a beautiful outdoor work space, kitchen or tabletop there are things you need to know before deciding to install IceStone outdoors.

- We are made from cement, cement continues to cure (we call it living and breathing) throughout its life and will continue to react to changes in temperature (high and low) that can cause it to crack. Though the cracking is usually hairline and will not affect the integrity of your counter it is something you need to know can happen and is not covered under warranty. We do not recommend installing IceStone in areas where temperatures reach extreme highs and lows.
- In addition to the outside temperatures, rain and snow can also have an adverse effect on IceStone. You must wipe down your countertops after it rains. It is never safe to leave water (or any liquid) on your IceStone counters for a period of time. Same with snow, you cannot let snow sit on the countertops. The acidity present in rain or snow will eat away at the sealer causing discoloration staining.

DO'S AND DON'TS

DO:

- We recommend to install IceStone in a covered outdoor section that is not in 100% direct sunlight and rainfall.
- Color Choice - though IceStone's sealer has a UV protectant in it we recommend ONLY installing light colors of IceStone outdoors (White Pearl, Alpine White) as the darker colors (Sapphire Snow etc) may tend to fade over time,
- As with all IceStone installations, IceStone must be reinforced during installation according to our guidelines
- Care of IceStone is the same for indoor or outdoor use. Please see our Care & Maintenance Guidelines. Some tips:
 - Wipe up spills immediately (remember IceStone will stain if liquids are left - we have a remedy for that but it's best to take proper care from the start)
 - Use only IceStone recommended cleaners to clean the surface
 - Check that IceStone's sealer is intact by doing the "water bead" test several times a year. IceStone will eventually need to be resealed. This is especially important for outdoor installations.
- Sealing Maintenance - like all of IceStone the sealer needs to be maintained to protect your countertops indoors or outdoors. Follow IceStone's guidelines for testing the sealer by doing the water test. We recommend this be done 1-2x per year and sealer reapplied to protect your IceStone countertop.

DO NOT:

- Do NOT install IceStone on top of metal cabinets without a substrate. The heat variation that the metal will transfer to IceStone and cause cracking
- Do NOT install IceStone flush to a grill or stovetop where heat will be transferred to the material. You must use insulation to protect IceStone just as you would with an indoor installation.
- Do NOT install IceStone where outdoor temperatures reach over 110 F on a consistent basis.
- Do NOT install a heavy pigmented color of IceStone outdoors in direct sunlight. Though UV protected the darker colors tend to react when in direct sunlight over time. Heavy pigmented colors such as Tuscan Sunset, Gotham Grey, Sapphire Snow, Fogbound etc. are not recommended. Please check with your sales rep or IceStone directly for color recommendations.

Fabrication Instructions

Fabrication Tools & Safety Equipment

Below is a list of critical tools and safety equipment needed to fabricate IceStone efficiently:

Basic Tools

- Bridge Saw
- Electric/Pneumatic Polisher (variable speed preferred)
- Diamond Grinding Wheel
- Diamond Polishing Pads
- Grinding Stone
- Core Bits
- Diamond Contour Blade
- Wet Profiling Machine (edge router)
- Stone Carts/Dollies
- A-Frame Storage Racks
- Stone (pony) Clamps
- Fabrication Stands
- Air Compressor
- Seaming Clamps
- Water Source
- Reinforcing Rods and Adhesives
- Forklift Truck with Boom and Lifting Clamp

Advanced Tools

- Water Jet
- CNC
- Automated Profiler
- Diamond Jig Saw
- Radial Arm Polisher

Basic Safety Equipment

- First-Aid Kit
- Safety Glasses
- Steel-Toe Footwear
- Respiratory Protection
- Work Gloves
- Aprons
- Ear Plugs
- Face Masks

Marble Institute of America Standards

IceStone recommends following the Fabrication and Installation Guidelines of the Marble Institute of America (<http://www.marble-institute.com>) and the Concrete Countertop Institute (<http://www.concretec countertopinstitute.com>) as applicable to quarried stone. Traditional stone fabrication equipment, such as CNC machines, bridge saws, routers, and polishers (with diamond pads and bits) should be used with water. A variety of fabrication machinery is used in every shop, so it is important to explore tooling and fabrication techniques to identify the best practices for your shop's equipment. For best results, IceStone recommends using high quality diamond blades and tooling suitable for use with hard granite.

Color Matching, Batch Numbering, and Slab Identification

VISUAL SLAB INSPECTION

Fabricators are responsible for immediately determining if the slabs are fit for use. If the slab is defective, contact Customer Service immediately and DO NOT cut or modify slabs in any way before exchanging the material with IceStone, LLC. Once a slab has been cut and/or installed, it can not be returned to IceStone, LLC for credit or refund.

A visual inspection for imperfections and color matching is essential when working with IceStone surfaces and should be standard practice before cutting. Inspect in lighting conditions similar to those at the installation site. Use the following as a checklist during inspection:

- Cracks
- Slab-to-slab color match
- Color inconsistency within the slab
- Warping/bowing
- Consistent gloss levels
- Glass segregation on the edges

Please note: Natural variations in color, size, shape and distribution of the pattern of the glass aggregate + the natural variations in concrete tone are all inherent characteristics and unique aspects of the product and should be expected.

Removing A Bow From Warped Slabs by Rewetting

Bowing occurs when an IceStone slab becomes warped or curved and is no longer flat. Bowing can occur when the slab is not clamped properly. Measure bow by using a 96" straight edge and a caliper. Hold the straight edge steady along the top of the backside (unpolished face) of the slab. Measure the bow along the top of the slab, at the midpoint of the long side (see **FIGURE 4**).

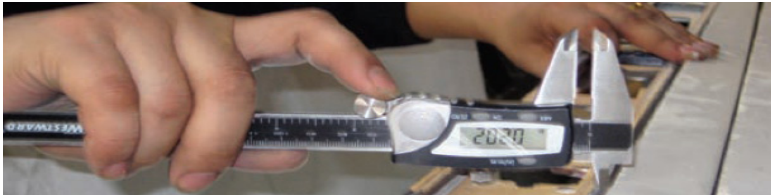

FIGURE 4

Use a caliper to properly measure slabs for bowing.

Slabs that have bowed beyond the acceptable level of 3.0mm (on the length of the slab) need to be removed from the inventory and rewetted following one of the procedures below:

Re-wetting Procedure:

1. Use a hose to continuously saturate the back of the slab with running water for 5 minutes. Make sure it is completely soaked. We use an overhead crane when soaking our slabs, for this part, but the IceStone can be placed on a pipe rack.
 2. Turn the slab around so that the polished side is facing out. Wipe the polished face of the slab dry before clamping.
 3. Once dried, move the slab to a pipe rack if it is not already on one, and clamp it to another slab of IceStone or granite
 4. Leave the IceStone slab clamped for 2 days, adjusting clamps daily. When adjusting clamps, tighten clamp only to first resistance. Clamping too tight will risk cracking the slab. After 2 days, measure the bow again. If the bow is still greater than 3.0mm, repeat the first three steps.
- After the bow on the slab is eliminated, wipe the face of the slab dry before moving back to inventory and clamping.

Fabricating IceStone

Traverse the slab no faster than 4 linear feet per minute (see **FIGURE 5**), as higher feed rates will result in excessive edge or glass chipping

When machining IceStone slabs on CNCs, take the following precautions to reduce the possibility of discoloration:

- Remove pieces as soon as they are completed
- Avoid leaving vacuum pods engaged overnight or for prolonged periods of time
- Clean vacuum pods routinely
- Replace worn or deteriorating vacuum pods
- WIPE DOWN ICESTONE DRY BEFORE REMOVING FROM TABLE



FIGURE 5

Run blades and tooling at a high RPM and flood slab with water at all times.

When routing IceStone sink openings or edge profiles, do not use segmented bits, as they increase the risk of chipping (see **FIGURE 6**). ***Do not leave water on IceStone, wipe and dry immediately!**



FIGURE 6

Routing IceStone sink openings

HAZING

During the fabrication process, slurry may dry on the surface of the slab causing a visual haze. To avoid the effects of hazing, saturate the surface often during fabrication. This haze can also be removed after fabrication using a non-scratch Scotch-Brite pad or 000 steel wool. ***Do not leave water on IceStone, wipe and dry immediately!**

FABRICATION INSTRUCTIONS
Any questions? Call us at 718-624-4900
www.icestoneusa.com

Radius Corners

IceStone surfaces require radius corners on all cutouts. The inside corners of IceStone cutouts and countertops must be shaped to a minimum of 1/4 inch radius to relieve corner stresses. Mitered or 90 degree corner seams do not need a radius. All outside corners of IceStone surfaces must be tooled to a minimum of 1/8 inch radius.

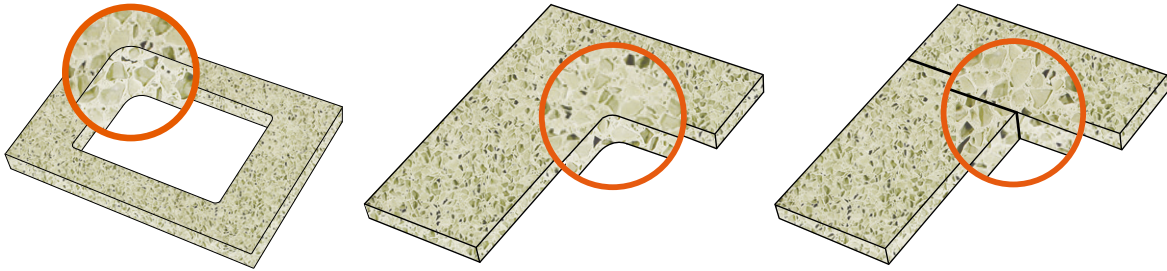

Edge Profiles

Always avoid installing IceStone with 90° edges, as this may lead to glass chipping and pop-outs. Edge profiles recommended by the Marble Institute of America are appropriate for IceStone surfaces, including the ones shown below.

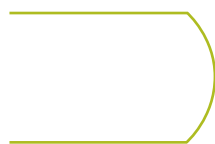

Radius Edge



Half Bullnose Edge



Ogee Edge

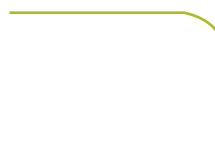

Pencil Edge



Full Bullnose Edge



Platner Edge

Glass segregation in some edge profiles may be pronounced. This can be addressed using a full bullnose, radius or platner edge.

Mitered Edges with IceStone

When mitering dropdown edges less than 6", it is recommended that the piece be rodded prior to cutting to help avoid breakage. In addition, anything 2" or less may develop cracks due to the inherent nature of the material and is not recommended.

Aprons and Built Up Edges

To avoid the visual effect of glass segregation, all built up edges should be mitred. IceStone slabs should not be stack laminated at visible edges. Laminating may create an undesired look if there is glass segregation in the slab edge. The joint should be clean, flush and parallel.



FIGURE 12
Example of properly built up edge (left), and improper stack lamination (right).

Recommended Edge Polishing Sequence

Edge polishing should be performed with sufficient pressure. Only use polishers that have a speed of 2,000rpm or higher, and high quality industrial diamond abrasive polishing pads. Polish using a sequence of increasingly finer pads to achieve a smooth, high quality, high gloss finish: #50, #100, #200, #500, #1000, #2000, #3000 and buffing pad.

Structural Support

FOUR SIDED PERIMETER SUPPORT

IceStone surfaces are strong enough that they do not require additional substrate support if a four sided perimeter frame exists for a countertop installation. However, front to back support is required for every 36 inches.

THREE SIDED PERIMETER SUPPORT

Additional support is required for structures that have perimeter support on three sides, such as vanity bases, desks and frameless cabinets. Installations with depths less than 26 inches require supports every 24 inches. Installations with depths over 26 inches require supports every 18 inches.

Cutouts and Reinforcing Rod Supports

- *It is extremely important that the fabricator follow the guidelines for support, and that proper support is installed for all installations and cutouts.
- If the general contractor did not install proper support, do not install IceStone.
- The fabricator needs to make sure that proper support is in place before installing IceStone.
- All warranties are void if icestone is not installed properly.

IceStone, LLC requires that all rough and finished openings be supported with reinforcing rods at both the front and back bridges to span a minimum of 6.0 inches beyond either side of the opening. Openings include but are not limited to cook tops, surface mount sinks, under mount sinks, down draft vents, etc.

IceStone, LLC recommends that reinforcing rods be 1/8 inch x 1/2 inch Fiberglass Rodder stock (or approved equivalent) set vertically in a 3/16 inch wide x 5/8 inch deep blade kerf (or space left by the saw blade after cutting) covered in Tenax Micto 2 Part Epoxy. IceStone, LLC recommends fiberglass rather than metal rodding because fiberglass will not oxidize over time and will physically bond to the adhesive (see **FIGURE 7 AND 8**).



FIGURE 7
Fiberglass rod and roll.



FIGURE 8
Saw kerfs for rodding.

Under Counter Sink Mounting Specifications

Stainless steel sink basins designed for under counter application should be mechanically anchored to the underside of the IceStone countertop using 3/8" x 5/8" diameter caulk-in-anchors with 10-24 machine screws (**FIGURE 9**) or with adhesive type hardware (**FIGURE 10**) or with approved equivalent. Heavier cast iron enamel and quartz composite sink basins require built-in cabinet support as per manufacturer's installation instructions and should not be mechanically attached to the IceStone countertop.

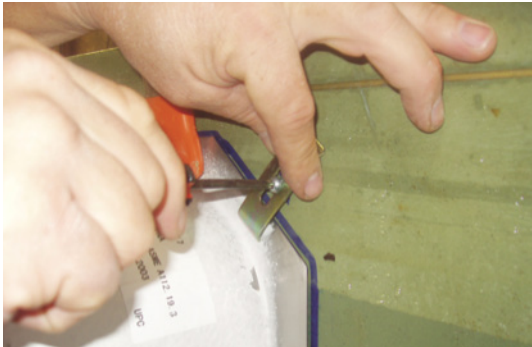

FIGURE 9

Undermount sink mounted with mechanical anchors.



FIGURE 10

Peel and stick sink mounting clip.

All undermount sinks should be adhered to the underside of the countertop using 100% silicone. Do not use solvent-based adhesives or plumbers' putty; they will stain IceStone surfaces.

All sink basins should be installed following manufacturer's instructions and by using manufacturer's supplied mounting hardware whenever possible.

Always follow manufacturer's specifications for sink basin rough opening and fixture drilling diameters and locations. Use manufacturer's provided templates whenever possible.

All under counter sink bowl cutouts must have the inside edge polished to match the IceStone surface.

Soap Dispenser Placement

Hand pump soap and lotion dispensers should be placed so that the spout drips into a sink bowl or basin and not on the countertop. Avoid using swivel dispensers. Foam soaps are recommended.

Extra support is needed for soap dispensers that are manual pump as there is additional stress put on the counter when pumping down.



FIGURE 11

Soap dispenser should drip directly into sink bowl.

Dishwasher Support

Dishwashers should not be attached directly to IceStone surfaces. Review the dishwasher manufacturer's specifications for the proper side mounting installation procedure. You can also attach the dishwasher to the cabinets by using a dishwasher mounting bracket.



FIGURE 13

Use a dishwasher mounting bracket to attach the dishwasher.

Cantilevers and Overhangs

Cantilevers and overhangs 9 inches or less do not require additional support.

Cantilevers larger than 9 inches require additional support at 24 inch intervals. Supports can be korbels, legs, columns or reinforcing rods.

Installation Overview

IceStone surfaces have a similar structural stability to quarried stone. We recommend the installation guidelines specified in the Marble Institute of America's Dimension Stone Design Manual (<http://www.marble-institute.com>). The recommendations below will offer additional guidance as you install IceStone durable surfaces:

- Use quality transport A-frames
- Always carry IceStone slabs on the vertical edge to avoid flexing
- A minimum of two installers are required for all projects
- Install only on level and plumb base cabinetry
- Top surfaces of the cabinets must be within 1/8" (3mm) of flat and level when measured across a distance of 10'-0" (3 m)
- Use shims when necessary
- Use 100% silicone caulking (or approved substitute) to adhere countertops to all substrates

To ensure accuracy before installing IceStone durable surfaces, use a template just as you would with quarried stone or quartz products. When templating, use traditional 'stick' templates or digital templating systems to ensure accurate fabrication.

1. Always remove existing surface tops prior to template.
2. Check all walls and base cabinetry to ensure everything is plumb and level. Scribe to the wall when the back edge is not square.
3. Mark all center lines on the template where there will be sink cutouts, cook-top rough openings, fixture drillings or electrical outlets.
4. Note the dimensions from cabinet to cabinet throughout the kitchen.
5. Double check all measurements and markings.
6. When nesting templates prior to cutting DO NOT mark IceStone slabs with ink pens or grease pencils.

Seaming

***As stated previously, slabs should be inspected prior to fabrication to ensure they color match whenever seaming is needed.**

In order to achieve a minimally visible seam, IceStone surfaces should be seamed with a color matched two – part polyester, epoxy or acrylic joint adhesive. The adhesive must be pigmented to match the slab being installed. Seams should be no more than 1/16 inch in width. Use seam setters to achieve best results. Tenax Rivo 50 A & B part knife grade epoxy can be tinted to color match with Tenax Tepox Epoxy colors. Tenax Rivo 50 A & B are VOC compliant under California regulation. An industry standard equivalent can be used as an alternative. Color match cartridge glues from Tenax USA are also an option for seaming IceStone.

Prior to installation, make sure that:

- Seams are supported to assure durability over time. Unsupported seams may buckle or sag.
- IceStone surfaces are properly sealed and waxed.
- Base cabinets are permanently anchored in place and are on a true plane completely leveled across all planes.
- A space of 1/8 inch exists between walls where the slab will be installed and the material (installations require at least 1/16" at each wall).
- Surfaces are placed level on top of cabinets or base; shim if necessary to ensure fit.
- Review all safety instructions and warnings before using any seaming products.

Always use 100% silicone adhesive to secure the slab to cabinetry or bases. Do not use cementitious grout between IceStone countertops and backsplashes.

Sealing



Watch how to seal on IceStone's YouTube channel:
youtube.com/user/IceStoneLLC

IceStone, LLC requires that fabricators ensure that the surface is sealed before or at the time of installation. IceStone ships pre-treated with our recommended sealer. All edges must still be treated with a sealer by the fabricator/installer after fabrication. IceStone will need to be resealed as needed by the end user. Please see the care and maintenance guidelines on page 31 for info on how to test if it's time to reseal. Apply one of the recommended sealers below according to the manufacturer's instructions. IceStone recommends the following two sealers:

Recommended Sealers	Tenax Proseal Nano	Laticrete StoneTech Enhancer PRO
Water Based		
Solvent Based	•	•
Penetrating Sealer	•	•
Minimal Odor		•
Low Volatile Organic Compounds (VOCs)		
Staining Protection	•	•
Etching Protection	none; wax after sealing	none; wax after sealing
Manufacturer	Tenax/Tenax USA	Laticrete
Telephone Number	1-800-341-0432	1-800-243-4788
Website	www.tenaxusa.com	www.laticrete.com

You can apply **CHENG Concrete Countertop Wax** after sealing for added protection.

Heat Tolerance

IceStone surfaces can withstand incidental heat contact up to 450° F. However, please note that the sealer and wax applied to the surface might not be heat resistant, so hot plates or trivets should be used under pots and pans recently removed from a heat source. Cook top appliances that are surface mounted require adequate insulation to prevent thermal conductivity between the appliances and the IceStone surface. Follow manufacturers instructions regarding insulation for freestanding ranges and ovens. Under-counter ovens should not be installed under IceStone.

Surface Repair

All spills should be wiped up in a timely manner. Spills to look out for are anything acidic such as red wine or coffee. If these are not cleaned up quickly- it may stain the IceStone.

Options for stain removal are below:

Scratches and Etch Marks



Watch how to remove etching on IceStone's YouTube channel:

youtube.com/user/IceStoneLLC

Minor scratches and marks can be buffed out of the surface using a powdered mixture and cotton cloth. Brands of powdered buffing mixture include Dia-Glo or Akemi Liquid Polish. Rub vigorously in small circles until the area is smooth.

Greater damage will require use of a low rpm electric polisher and dry polishing diamond pads. Because the glass in the IceStone surface is harder than the cement, start with the highest abrasive (3000g) and work down (2000g, 1000g) until the damage is gone, then reverse the steps (1000g, 2000g, 3000g) until the marks are gone. Seal the surface after removing the marks.

You can apply CHENG Concrete Countertop Wax after sealing for added protection and to help minimize the appearance of minor surface marks.

Removing Stains



Watch how to remove stains on IceStone's YouTube channel:

youtube.com/user/IceStoneLLC

Using a poultice is an effective method of removing stains from IceStone. Make sure to test the poultice on an inconspicuous area to ensure there will be no discoloration from the procedure. Our recommended poultice is Stain Proof Alkaline Cleaner.

To remove stains, you will need the following:

- Acetone
 - Water
 - Plastic Wrap
 - Painter's tape
 - Stain Proof Alkaline Cleaner (for organic stains)
 - Recommended Sealer
 - *Optional: CHENG Concrete Countertop Wax
1. Remove residual sealer and wax from the surface with acetone.
 2. Identify the staining agent.
 3. Select the appropriate poultice for the stain. Stain Proof Alkaline Cleaner works well for most organic stains. If you have questions about a particular staining agent, contact IceStone Customer Service.
 4. When using Stain Proof Alkaline Cleaner, mix with water into a thick paste and apply to the stain. Cover with with plastic wrap, using painter's tape to hold in place. Let sit for 24 hours, then remove and rinse with clean water; air dry.
 5. If the stain still persists, repeat instructions in step 4.
 6. Always seal the surface after removing staining. You can apply CHENG Concrete Countertop Wax after sealing for added protection.

Pop Outs



Watch how to fill in pop-outs on IceStone's YouTube channel:

youtube.com/user/IceStoneLLC

Shellac can be used to fill any large voids over 2.0mm in the IceStone surface. Contact IceStone for availability of shellac customerservice@icestoneusa.com

To fill pop outs, you will need the following materials:

- Shellac pieces that match the matrix color
- Small metal spatula
- Razor blade
- Electric burner or heat gun



1. Heat the metal spatula by resting the blade on the electric burner.
2. Use hot metal spatula to press shellac into the void. If the pop out is particularly large, break off small pieces of shellac so that the cavity is filled. Use the metal spatula to melt more shellac until the void is full. There should be no air bubbles.
3. Wait 1 minute until the shellac has cooled and hardened. Use a sharp razor blade to scrape off excess shellac from the surface of the slab. Void should be filled, leveled with the rest of the surface, and smooth.
4. If the void was not successfully filled, use a razor to remove the shellac from the void and try again.
5. Wipe surface around shellac with a clean rag and acetone.



Watch how to fill microporosity on IceStone's YouTube channel:

youtube.com/user/IceStoneLLC

Microporosity

IceStone, LLC has developed a patching method that is recommended for any small surface problems like pinholes or slight discoloration. The patching kit is available by order from IceStone, LLC. If there are large voids in the surface (larger than 2.0mm), follow the Pop outs procedure listed on page 28.

You will need the following materials and tools:

- Patching kit (a color matched cementitious mix provided by IceStone)
- Plastic spatula or spoon for stirring
- Metal mixing bowl
- Water
- Grout float
- Clean rag



1. Mix the dry patching kit in the metal bowl to ensure pigments are dispersed evenly.
2. Add 40 grams of clean cold water to the mixture.
3. Stir until the mixture is smooth. The mixture should be thicker than pancake batter but not as thick as peanut butter. Add more water (5 g at a time) if necessary. The less water used, the stronger the concrete will set.
4. Wet the whole surface with a spray bottle of water. Empty half of the mixture in one line in the middle of the IceStone. One bag of patching powder makes enough slurry for 2 slabs.
5. With circular motions spread the slurry evenly over the face of the slab with the grout float, making sure the whole surface is covered.



6. Scrape excess slurry into the mixing bowl. Make sure the patch dries in a consistently thin layer. Areas with too much patch will appear discolored and will require reworking.



7. Wait until the patch has completely dried. Once dry, wipe off all the dried material from the surface with a clean cotton cloth. The pores should be filled and level.

For Your Customer

The following pages (30-33) include the information you must provide to your end user upon installation. Make a copy, download on our website at icestoneusa.com, or request by emailing customerservice@icestoneusa.com. The fabricator is responsible for making sure the end user has a copy of the following:

- **Care & Maintenance Guidelines**
- **Warranty Registration Form**



IceStone Care & Maintenance Guidelines 1/2

ABOUT YOUR ICESTONE SURFACE

IceStone is manufactured without any petrochemicals or resins, making it an environmentally responsible choice for countertops in the home or office. Care of IceStone is similar to that of natural stone. Like all surfaces, IceStone will show signs of wear and tear over time. With sensible care, you can maintain the beauty and quality of your IceStone surface.

CARING FOR YOUR ICESTONE

GENERAL CLEANING

Use the products recommended in these guidelines. Cleaning products should be free of chlorine bleach, ammonia, acid and citrus scents.

WIPE UP SPILLS

Be especially attentive to spills such as coffee, wine, fruit juices and other acidic liquids, wiping them up promptly with a damp cloth and water.

USE TRIVETS AND CUTTING BOARDS

Place a tray under coffee machines, soap, and soap dispensers—as with all surfaces, use trivets and cutting boards to help protect the sealer and the surface.



PROTECT YOUR SURFACE

IceStone is very dense, but still porous, so surfaces must be sealed. IceStone requires that the fabricator seals before or at the time of installation.

A typical IceStone installation requires annual resealing. To determine if it is time to reseal your IceStone, dab a cotton ball in water and evenly wipe the surface in a straight line.

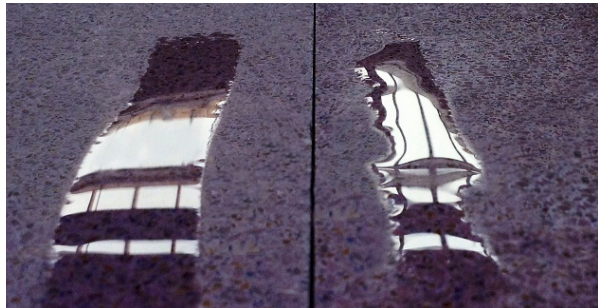

TIME TO RESEAL

If the watermark is wide and flat.

SEALER IS INTACT

If the watermark is raised and has irregular edges.

Sealing is simple! While you can certainly call in a professional, most homeowners opt to do it themselves. We have made it even easier by providing a video tutorial on sealing on the IceStone YouTube channel:

www.youtube.com/user/IceStoneLLC



You can apply **CHENG® Concrete Countertop Wax** after sealing for added protection.

IceStone Care & Maintenance Guidelines 2/2

RECOMMENDED PRODUCTS

* Using products other than those recommended on IceStone can result in less than optimal performance of the material.

CLEANERS

Seventh Generation® All-Purpose Cleaner | Free & Clear
Method® All-Purpose Natural Surface Cleaner | Lavender
Method® Daily Granite Cleaner



SEALERS

IceStone recommends Laticrete Stonetech Enhancer Pro Sealer or Tenax Proseal Nano when resealing.



CONTACT US

Thank you for selecting IceStone surfaces. We are continuously researching new products that make it easier for you to care for your surface. Please visit our website or call us for the latest information about care and maintenance.

IceStone, LLC | customerservice@icestoneusa.com | 718.624.4900



REPAIRS

REMOVING TOUGH STAINS

Staining is caused by liquids that have penetrated and discolored the surface. Most stains can be removed by using a poultice. Refer to our video illustrating stain removal on our YouTube channel: www.youtube.com/user/IceStoneLLC



REMOVING SURFACE MARKS/ETCHING

Etching is caused by acidic liquids that have discolored, dulled, and/or eroded the surface.

If etching occurs, contact IceStone Customer Service: customerservice@icestoneusa.com

WARRANTY

IceStone offers a Residential 10-year Limited Warranty and a Commercial 5-year Limited Warranty for installations that are fabricated and installed by an IceStone Certified Fabricator. Register your warranty on our website.

IceStone Warranty Registration Form

Please go to icestoneusa.com/customer-service/warranty to register your warranty. Alternatively, complete the form below and send via email to customerservice@icestoneusa.com or fax to 718.624.4002. Your warranty must be registered within 30 days of installation.

Building/Homeowner Name: _____

Type of Installation: _____ Commercial _____ Residential

If Commercial, Project Name: _____

Project address:

_____ Street _____ Apt/Suite

_____ City _____ State/Province _____ Zip/Postal Code

_____ Country

Building/Homeowner Phone Number: (____)____-_____

Building/Homeowner Email Address: _____

IceStone Color(s) Installed: _____

Type of Construction: _____ New Construction _____ Remodel

Estimated Square Footage Installed: _____

Usage _____

(ie. Kitchen Countertop, bathroom vanity, outdoor application, reception desk, etc)

Did you receive the Care and Maintenance Guidelines? (circle one) : Yes/No

Fabricator Company Name: _____

Installer Company Name: _____

Purchase Date: ____/____/_____

Installation Date: ____/____/_____

Panel ID Number(s): _____

Brand of Sealer Used: _____

Brand of Wax Used: _____

Would you like to receive email updated on IceStone Care & Maintenance Guidelines? Yes/No

(Choose "Yes" for reminders to do a water test to determine if it is time to reseat your surface)



IceStone[®]
MADE IN THE USA

www.icestoneusa.com

T 718 624 4900 | E customerservice@icestoneusa.com

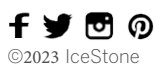

©2023 IceStone